

Snabbfästen, Link Launcher[®]

Monteringsinstruktion

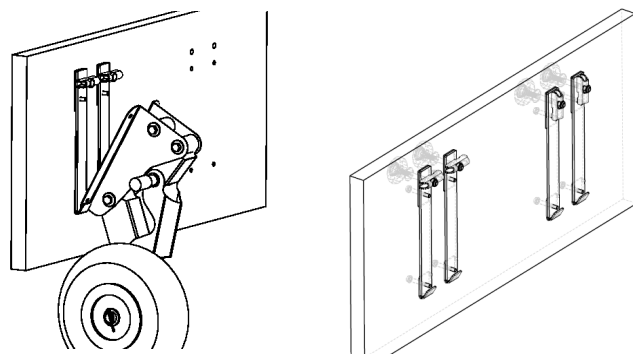

Komponenter som ingår:

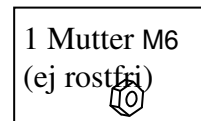
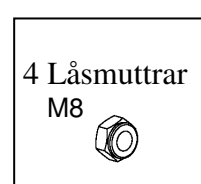
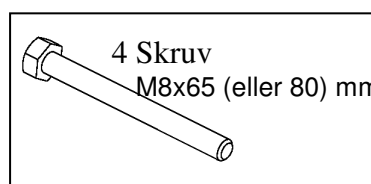
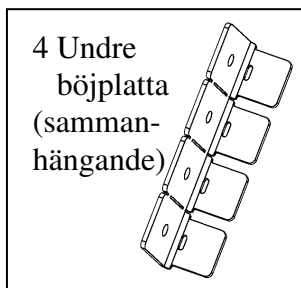
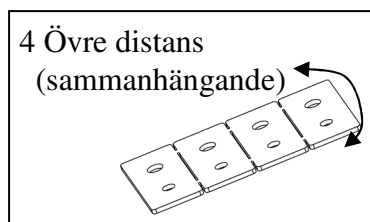
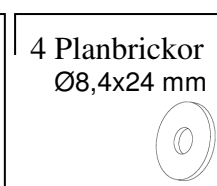
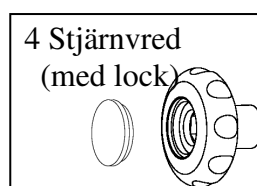
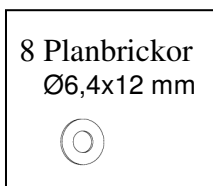
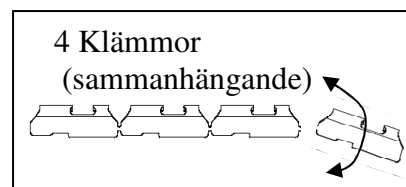
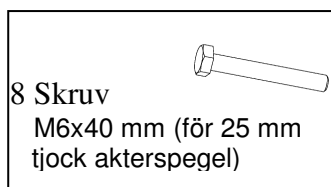
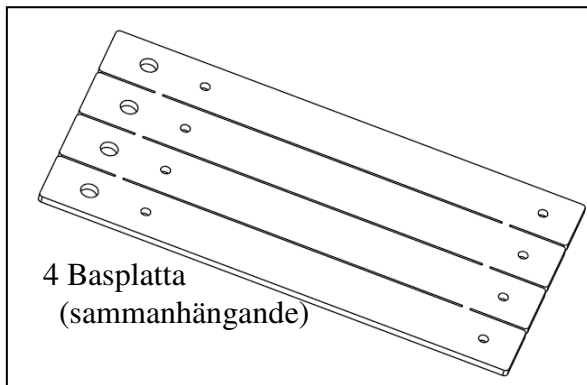

Installation:

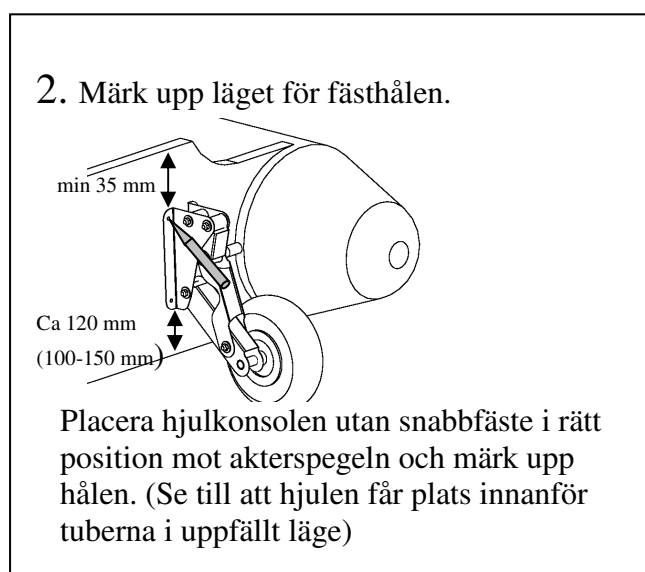
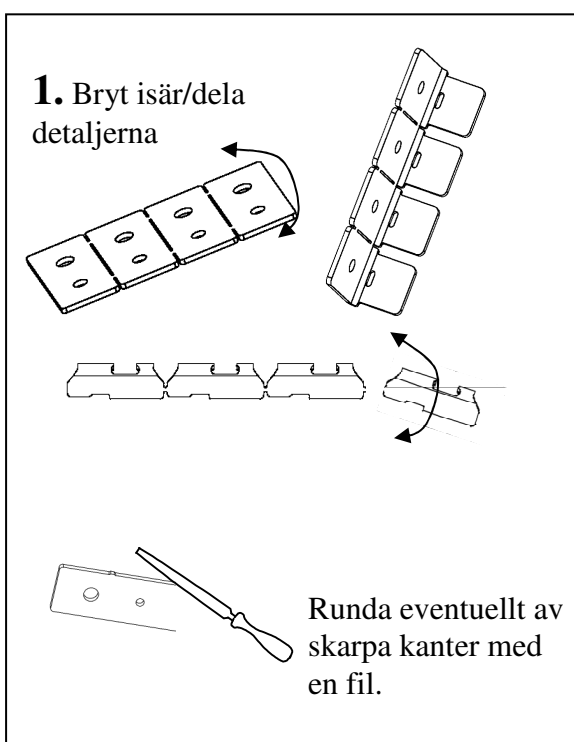

3. Borra

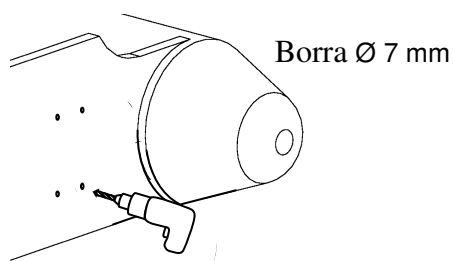

4. Montera detaljer

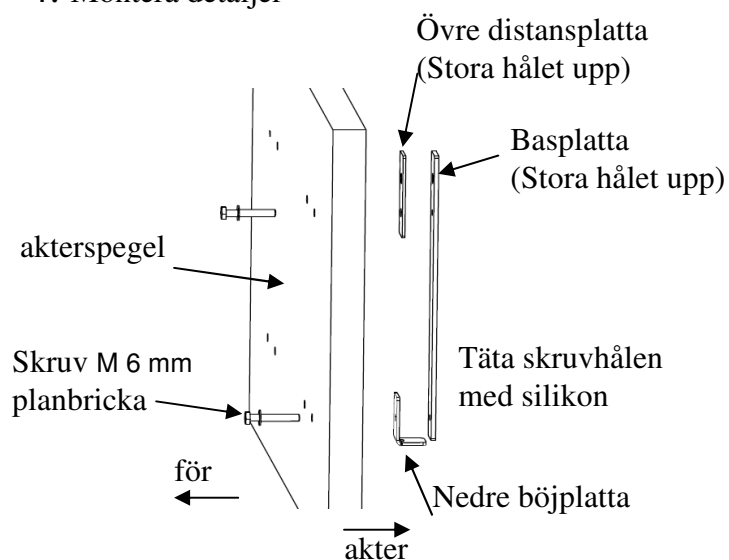

5. Kapa skruvar till rätt längd (utstick ca 5 mm, mutter används för rätt mått)

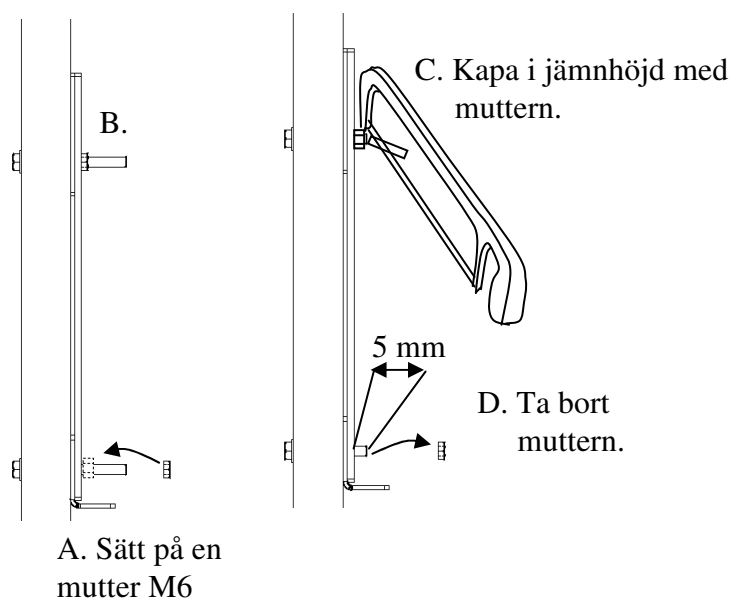

6. Borra Ø 8,5 mm genom akterspeglens (översta hålet)

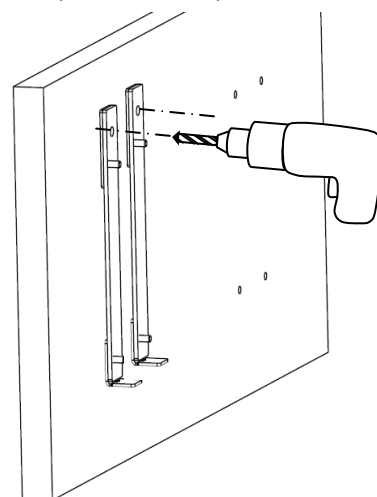

7. Montera klämmorna

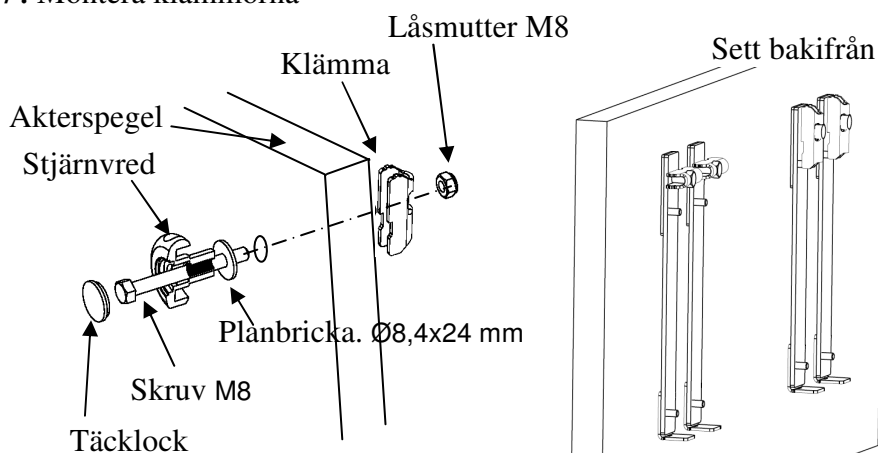

Alternativ:

Om skruven inte är för lång kan man istället sätta muttern i vredet för "dold skruvgänga".

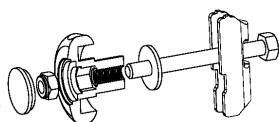

8. Montera hjulen.

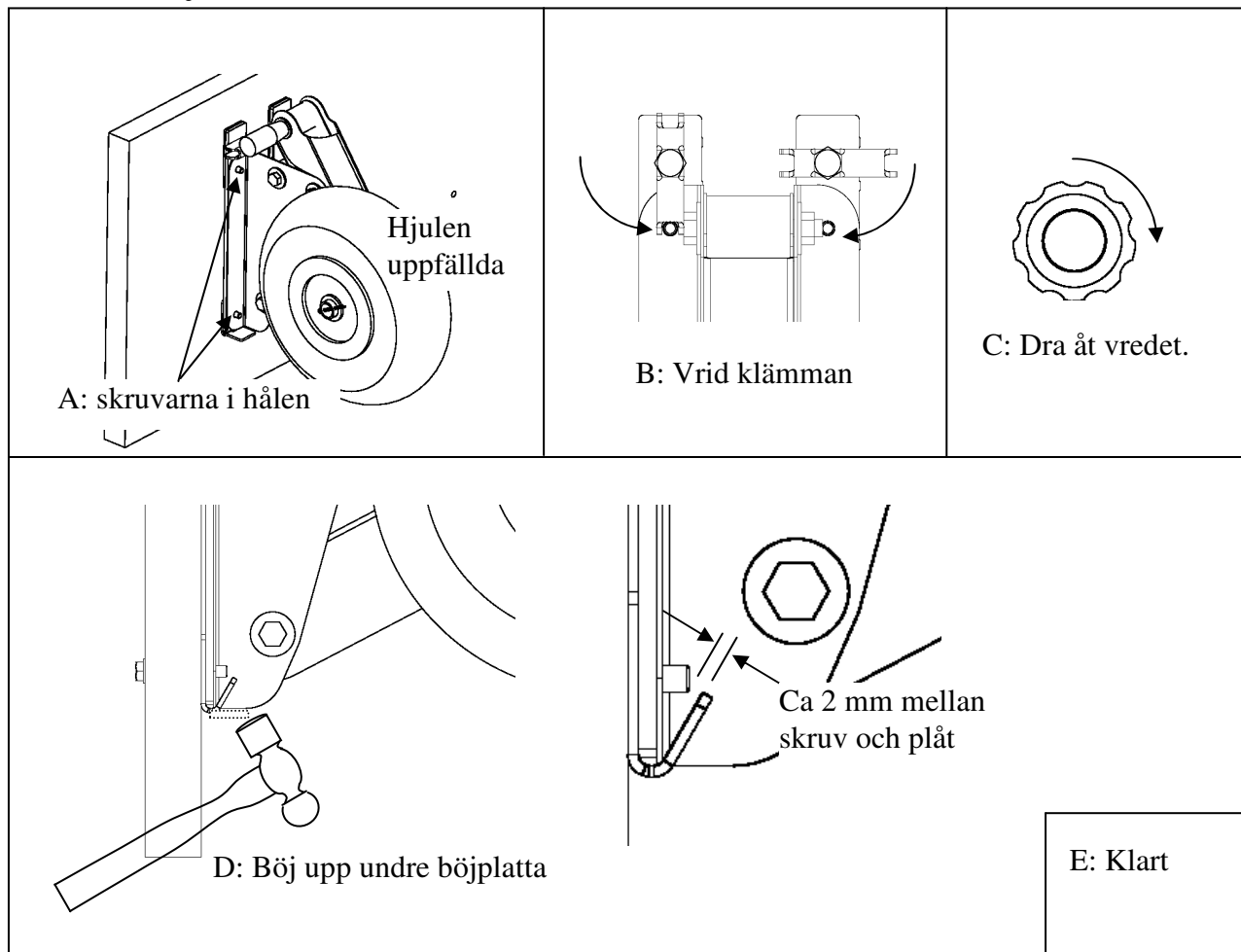

9. Dags att använda snabbfästet. Tag loss hjulen.

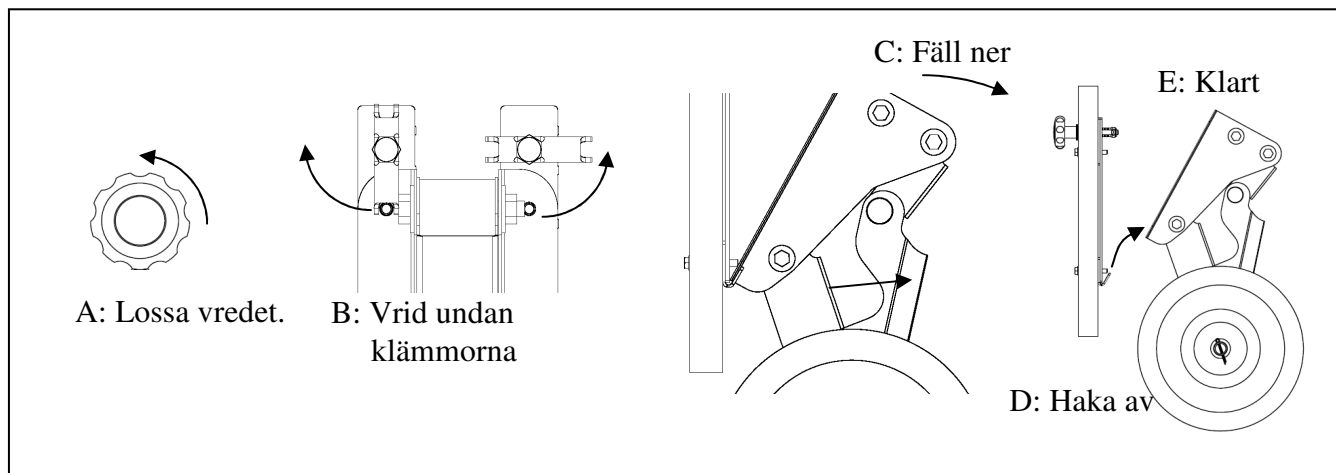

10. Vid montering görs punkt 9 i omvänd ordning.